

MAAX[®]



P E A R L

WHIRLPOOL BATHTUB OWNER'S MANUAL

10050073

Safety, Operation, Maintenance, & Warranty SAFETY GUIDELINES

This manual contains information for you. This information relates to YOUR SAFETY and will also help in PREVENTING PROBLEMS. To help you recognize these items of importance, we will use the following symbols. PLEASE read the manual and pay special attention to these sections.

SAVE THESE INSTRUCTIONS!!!

! DANGER !

URGENT SAFETY INFORMATION -
A HAZARD THAT **WILL** CAUSE SERIOUS INJURY!

WARNING

IMPORTANT SAFETY INFORMATION -
A HAZARD THAT **MIGHT** CAUSE SERIOUS INJURY!

CAUTION

INFORMATION TO **PREVENT DAMAGE** TO
EQUIPMENT.

Model: _____

Serial #: _____

Owner's Record

Installation Date: _____

Installer's Name: _____

Address: _____

Telephone: _____

This information may be required for service and warranty.

IMPORTANT SAFETY INSTRUCTIONS

BASIC PRECAUTIONS TO BE TAKEN TO PREVENT FIRE HAZARDS, ELECTRICAL SHOCKS, PERSONAL INJURY OR DAMAGE WHEN USING YOUR UNIT.

READ AND FOLLOW ALL INSTRUCTIONS!

! DANGER ! Urgent safety information;

THE UNIT MUST BE CONNECTED TO A POWER SUPPLY CIRCUIT THAT IS PROTECTED BY A GROUND FAULT CIRCUIT INTERRUPTER (GFCI). A GFCI should be provided by the entrepreneur electrician and should be routinely tested. To test the GFCI, push the test button. The GFCI should interrupt power. Push the reset button. Power should be restored. **If the GFCI fails to operate in this manner, there is a ground fault, indicating the possibility of electrical shock. DO NOT USE THE UNIT.** Disconnect the unit and have the problem corrected by a qualified electrician before using.

Never operate electrically connected devices in or near the bath. Never drop or insert any object into any opening. Do not use electrical appliances while in the tub.

To reduce the risk of injury, do not allow children to use this unit unless they are closely supervised at all times. Those requiring supervision should never be allowed to use the units unattended.

Use the unit only for its intended use as described in this manual. Do not use attachments not recommended by the manufacturer.

Never drop any objects into any openings.

Do not use the whirlpool if the protective cover is not installed on the suction intake. Keep foreign objects, including hair, away from the suction intake as they could block the intake or get caught in it. For comfort and safety, persons with long hair should tie their hair in a bun to keep it out of the water and away from the suction fitting. Keep your head above water at all times.

WARNING Important safety information;

Persons under a doctor's care, pregnant women, persons with high or low blood pressure, heart disease, diabetes, or any serious illness, should not use this unit without prior consultation with their physician. Never use this unit while under the influence of any drug or alcohol.

The maximum temperature of the water should never exceed 104°F (40°C).

CAUTION Information to prevent damage to equipment;

To reduce risk of injury, enter and exit the bath carefully.

Do not fill the tub beyond the air volume controls or the overflow.

Never operate the whirlpool system if there is less than 2" (5 cm) of water over the highest whirlpool jet (except for the back jets) or if the bathtub is empty.

Do not bathe pets in your whirlpool. Their hair could clog the pump.

Make sure the water temperature does not exceed 104°F (40°C). Damage and discoloration of the acrylic surface may occur.

The whirlpool should be drained after each use.

Oil-based additives can be used, **but only if the frequency and cleaning instructions are followed.**

Do not use harsh abrasives or solvents for cleaning your whirlpool.

• SAVE THESE INSTRUCTIONS •

TABLE OF CONTENTS

IMPORTANT SAFETY INSTRUCTIONS	2
COMPONENT IDENTIFICATION	
<i>TRUE WHIRLPOOL® & AEROFEEL®</i>	4
<i>TRUE WHIRLPOOL® & AEROEFFECT®</i>	4
<i>TRUE WHIRLPOOL® & AEROEFFECT®</i> with Air Push	5
Whirlpool Pump	5
Patented Whirlpool Jets	5
Air Volume Controls	5
Patented Safety Suction Return System	5
Back Massage System / Comfort Package	6
In-Line Heater	6
Skirt with Removable Panel - Field Installed	6
Integral Flange & Skirt with Removable Panel	6
Bath Waste	6
Valves & Hand Held Spray	6
OPERATING THE CONTROLS	
Air switch pump control	7
Electronic control with back lighting <i>TRUE WHIRLPOOL®</i> and <i>AEROFEEL®</i> systems	7
Electronic control <i>TRUE WHIRLPOOL®</i> and <i>AEROEFFECT®</i> systems	8
Electronic control Chromatherapy Light	8
HOW TO USE YOUR WHIRLPOOL BATH	9
USER MAINTENANCE INSTRUCTIONS	
Cleaning the Tub Surface	11
Commercial Installation (Cleaning)	11
Cleaning the Pump and Plumbing System	11
Minor Scratches and Scuffs	11
Major Repairs to the Surface	11
Jet Hardware Wrench	11
TROUBLESHOOTING	
Whirlpool System	12
Air Systems	12
Cable operated drain & overflow	13
In-line Heater	13
LIMITED WARRANTY	
Limitations	14
Commercial Limitations	14
Warranty service	14

Dear Homeowner,

Thank you for choosing MAAX Pearl. The minute you sit back and relax in your new bath you'll see and feel the difference. In your whirlpool, jets are strategically placed to create a soothing, swirling flow of relaxing water. It's *TRUE WHIRLPOOL®* action you'll only experience in a MAAX Pearl.

Relax and enjoy!! There's only one *TRUE WHIRLPOOL®*.

Sincerely,
Pearl Baths, Inc.

COMPONENT IDENTIFICATION

Note: These drawings represent only the major components of the system; the position of the components may vary depending on the bath model.
Note: These drawings represent Combined Systems; Whirlpool Systems components are identified with "1" and Air Systems components are identified with "2".

TRUE WHIRLPOOL® & AEROFEEL®

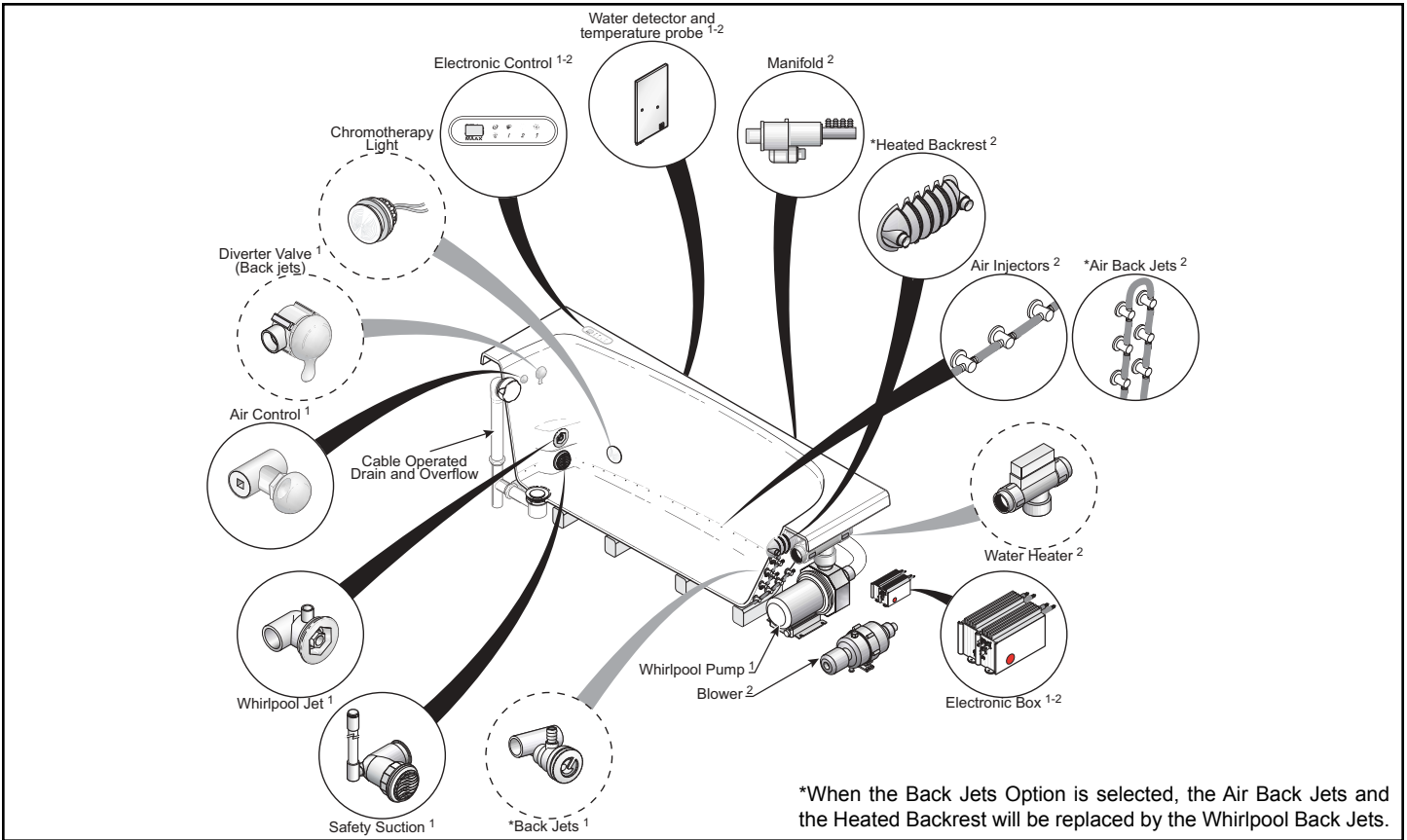

TRUE WHIRLPOOL® & AEROEFFECT®

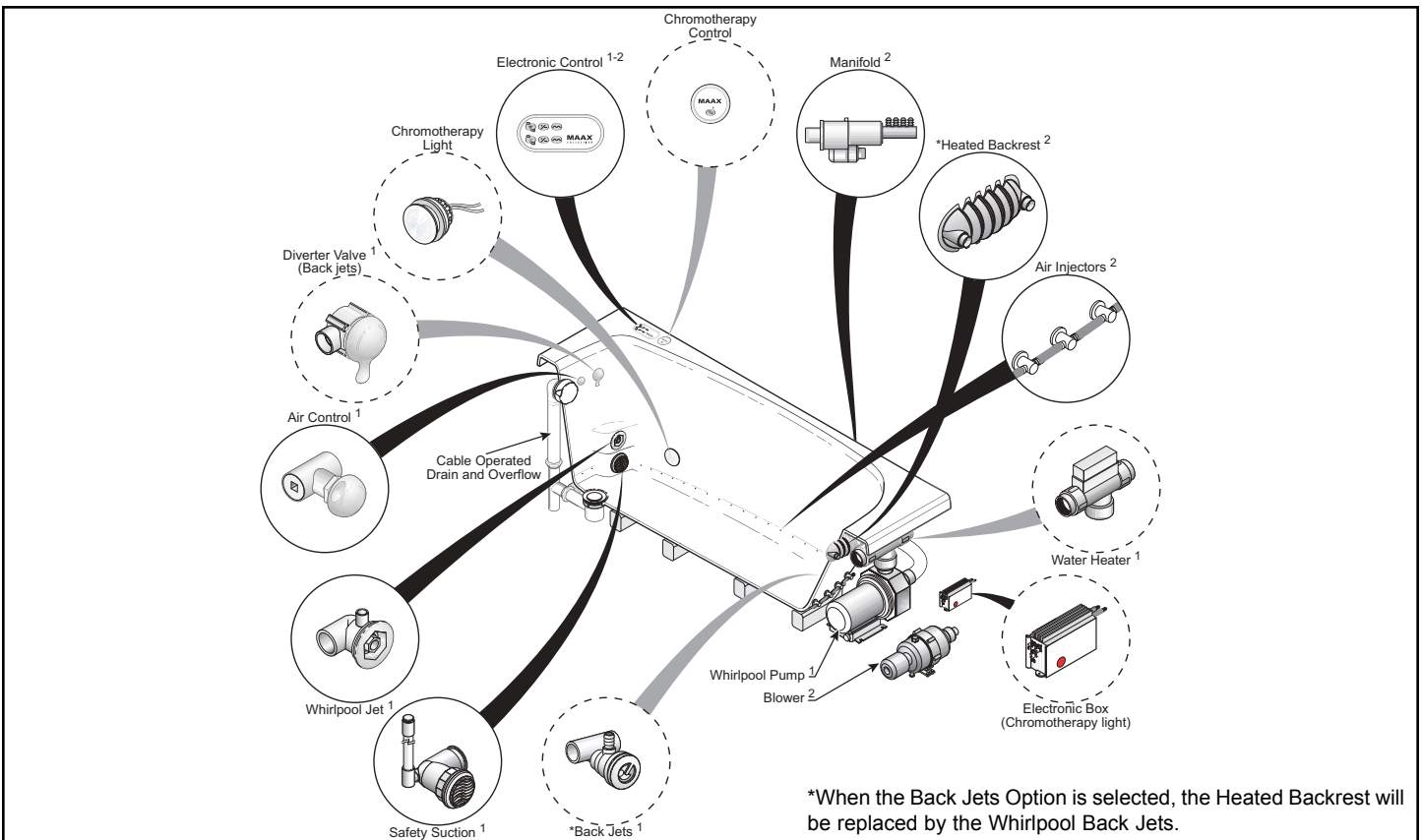

TRUE WHIRLPOOL® & AEROEFFECT® WITH AIR PUSH

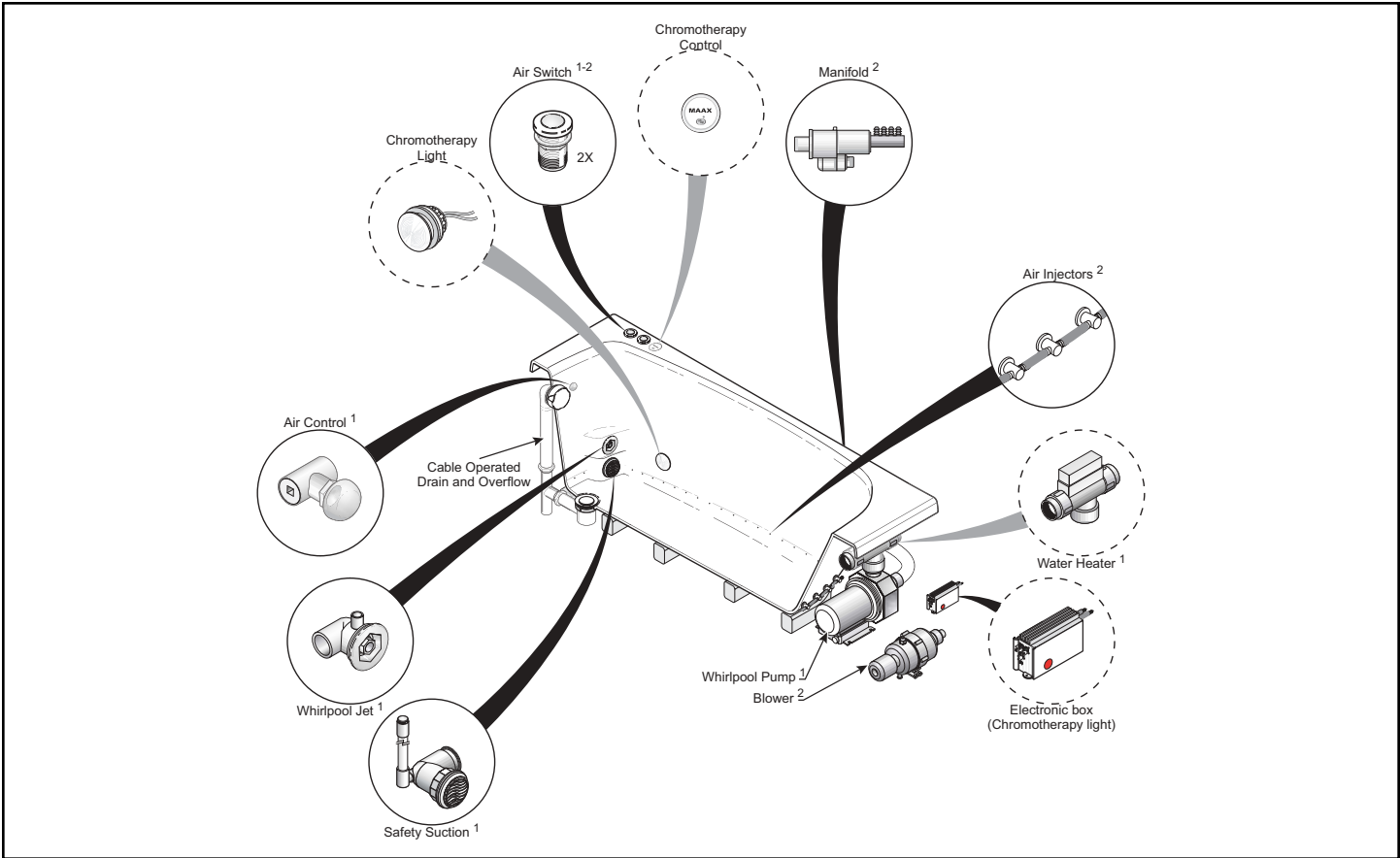

WHIRLPOOL PUMP

Our commercial quality pump is the heart of your whirlpool system. The pump is positioned on a specially designed cantilevered mounting base. It helps isolate and dampen vibration and noise, adding to your comfort and pleasure.

PATENTED WHIRLPOOL JETS

Pearl Whirlpool Bathtubs are not ordinary jetted tubs. Jet location in our tubs is designed to give you the very best in whirlpool bathing. The nozzle is directionally adjustable and turns over a 30° range. Fig. 1.

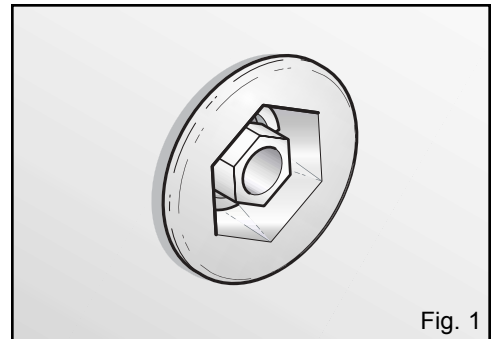

Fig. 1

AIR VOLUME CONTROLS

Each jet is moving approximately 30 gallons of water per minute. The more air that is introduced into the flow of water, the deeper the massage. The amount of air is regulated by the air control knobs. Two air controls, (as shown in fig. 2) are located inside the tub. One knob controls a single jet. The other controls one or two whirlpool jets, depending on your model. Do not fill the tub above the air controls or overflow.

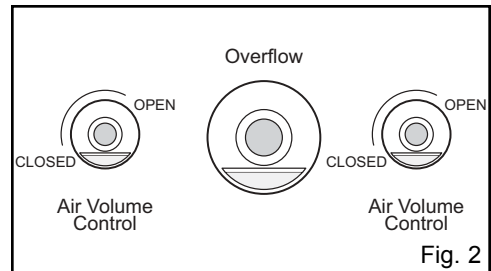

Fig. 2

PATENTED SAFETY SUCTION RETURN SYSTEM

This fitting allows water to return from the tub to the pump. The protective louvered screen prevents foreign objects from entering the pump. **Do not use the whirlpool bath if protective cover is missing. Do not remove the protective louvered cover (fig. 3).** Keep the cover of the return fitting clean. An obstructed cover reduces the whirlpool action and may cause damage to the pump. To clean, remove any hair or debris and wash cover with a soft brush and soap. If blockage occurs, such as a foot, or hand too close to the return fitting, the pump instantly disengages and stops the whirlpool action until the obstruction is removed. Please do not be alarmed. This is a safety feature designed for your protection.

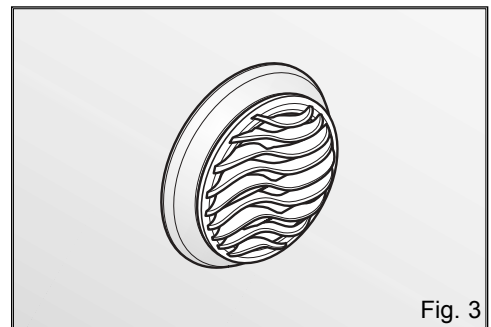

Fig. 3

BACK MASSAGE SYSTEM / COMFORT PACKAGE

The ergonomically-positioned jets provide a stimulating massage action to those sore tired muscles. The intensity of these rotating jets can be adjusted by turning the diverter valve located on the side of the bath (fig. 4). Turn the diverter valve to either the 3 o'clock or 9 o'clock position. Never turn to 12 o'clock position.

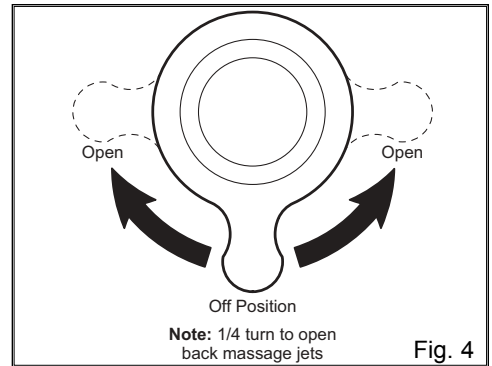

Fig. 4

IN-LINE HEATER

The In-Line Heater (fig. 5) is designed to maintain the starting water temperature. The heater is not a substitute for an adequately sized water heater. Proper water heater size should be determined by a plumber prior to the whirlpool installation. During bathing, it is normal to experience an impression that the water is cooling. This is the result of the body becoming acclimated to the water temperature. You may want to purchase a water thermometer to verify actual temperature. THE HEATER MUST HAVE A SEPARATE 20 AMPS LINE (GFCI PROTECTED).

High Limit Reset Button

The heater includes an exclusive High Limit Reset. This limit control will not "false trip" from hot tap water. It will only turn the heater off if the thermostat fails. See instruction on heater for resetting high limit switch. If the High Limit trips frequently, call our Technical Service Department (fig. 5).

Safety Features

In addition to the thermostat control and High Limit Reset Button, the heater is also equipped with a built-in pressure switch. This switch will not allow the heater to turn on if the pump is not running.

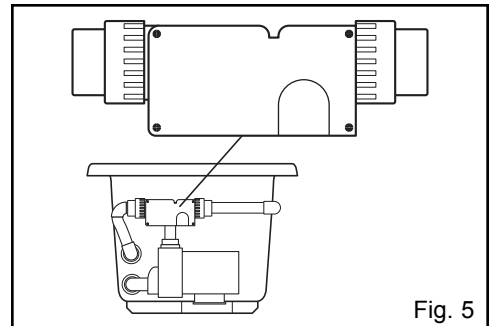

Fig. 5

WARNING The thermostat is preset and not adjustable. Water temperature should never exceed 104° F. (40°C). Prolonged use in water temperature higher than this could induce hyperthermia. Hyperthermia occurs when the internal temperature of the body reaches a level several degrees above the normal body temperature of 98.6°F. The symptoms of hyperthermia include an increase in the internal temperature of the body, dizziness, lethargy, drowsiness, and fainting. The effects of hyperthermia include failure to perceive heat, failure to recognize the need to and the physical inability to exit the tub, unawareness of impending hazard and fetal damage to pregnant women. The effects of hyperthermia could include unconsciousness resulting in the danger of drowning.

The use of alcohol, drugs or medication can greatly increase the risk of hyperthermia.

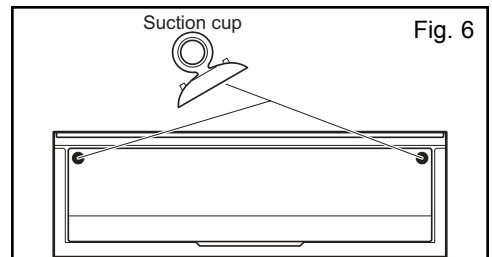

Fig. 6

SKIRT WITH REMOVABLE PANEL - FIELD INSTALLED

**Available on rectangular drop-in units.*

The front skirt is installed permanently in place by the installer. The panel can be pulled out (Fig. 6) to service the pump.

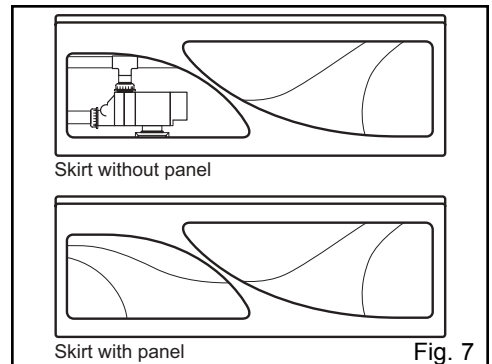

Fig. 7

INTEGRAL FLANGE & SKIRT WITH REMOVABLE PANEL

The skirt and panel are standard features on these models. To remove the access panel, use the supplied suction cup to release one side of the panel at a time. Pull from the center (upper) of the panel.

BATH WASTE

The drain plug has an adjustable screw and locking nut to vary the overall length of the plug. If the bath waste drain does not seal, turn in the screw and retighten the locking nut (fig. 8).

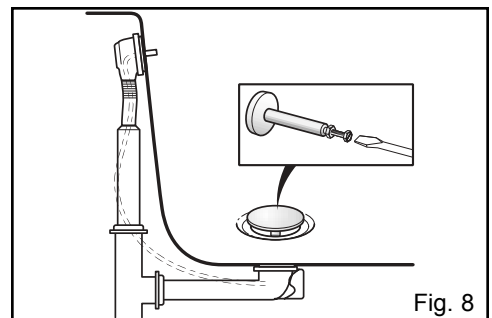

Fig. 8

VALVES & HAND HELD SPRAY

Standard with PALLADIUM™ and TRILLIUM™.

Designed for convenience and function, yet sculpted into their own special place. The spray is adjustable on the spray head itself, from full spray to stream. Push the diverter down to change from tub fill to hand held spray. The valves are ceramic requiring only a 1/4 turn for on/off operation (fig. 9).

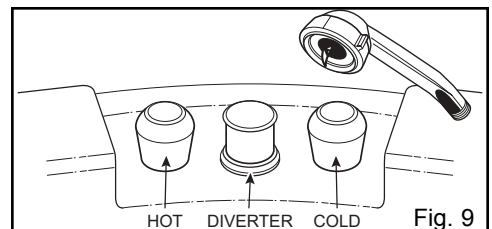
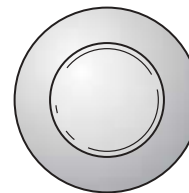

Fig. 9

OPERATING THE CONTROLS

AIR SWITCH PUMP CONTROL

The air switch pump control (fig. 10) allows on/off control operations from within the tub.







Air Switch

Fig. 10

ELECTRONIC CONTROL WITH BACK LIGHTING *TRUE WHIRLPOOL® AND AEROFEEL® SYSTEMS*

Functions

-  **Sets pump(s), blower and/or light run time.**
Turns all controls off.
Sets the water temperature display preference (°F or °C).
-  **Starts and stops the pump(s).**
Sets water jet speed. Speed options range from SP6 (high) to SP1 (low) and PUL (massage).
-  **Starts and stops the option** (second whirlpool pump, *THERMAZONE™* option)
-  Turns on/off the chromatherapy light option.
-  Starts and stops the blower.
Adjusts the speed and intensity of the airflow through the air jets. Speed options range from SP6 (high) to SP1 (low) and PUL (massage).

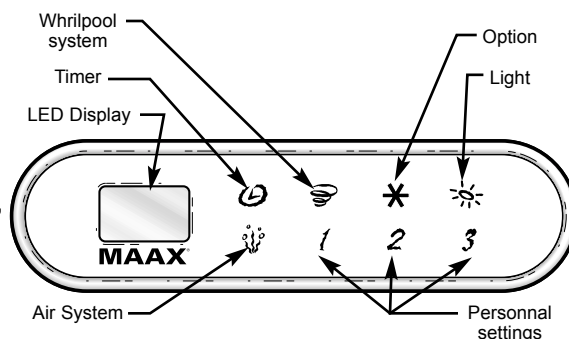





Fig. 11

1 2 3 Stores and retrieves up to three (3) personal controller settings.

Once the controller detects the appropriate level of bath water, the Timer control  lights up and flashes. This indicates that the water temperature display preference can be set.

Set the water temperature display preference (°C or °F)

Note: Setting the water temperature display preference is optional, but if you wish to set it, you must do so before setting any other controls. The water temperature display preference only has to be set once, as it is permanently stored in the controller's memory.

1. Press and hold the timer control  (for about 10 to 15 seconds) until it eventually displays a "°C" (Celsius) and an "°F" (Fahrenheit), flashing alternately.
2. Release the timer control when either the "C" or "F" is displayed, depending on your preference. "OFF" appears briefly on the LED display, then the timer control  lights up and flashes.

Note: You must set the timer before you can set the remaining controls. Once you set the timer, the timer control remains lit, but stops flashing. Also, with the exception of the custom settings controls, any other controls that you can set (depending on your model type) light up and flash. You can set the remaining controls in any order you wish; their lights stop flashing after you set them.

Setting the Timer

1. Ensure the timer control light is flashing (the controller detects bath water).
2. Press and hold the timer control  (the LED cycles through the available timer settings: 10, 15 and 20 minutes).
3. Release the control when the number of minutes desired is displayed on the LED.

Note: At any time, you can change (increase) the timer setting without interrupting operations simply by pressing and holding the timer control then releasing it when the desired timer setting appears on the LED Display.

Starting and setting the Pump and/or Blower Speed

1. **Single-speed pump/blower:** Press on the pump control(s) and/or blower control to start the pump(s) and/or blower. The "On" option appears on the LED Display.
2. **Variable-speed pump/blower:** Press and hold one of the pump controls or the blower control (the LED display cycles through the available speed settings: SP6 (high) to SP1 (low) and PUL (massage)).
3. Release the control when the LED displays your desired selection.
4. Repeat steps 1 through 3 for each pump and/or blower.

Note: For the *AEROFEEL®* system, a one-minute drying cycle starts up 20 minutes after the blower is stopped and the tub is empty. For the *AEROEFFECT®* system, the drying cycle starts up 20 minutes after the blower is completely stopped.

Starting the Option *

1. Press and hold the * control (the LED display cycles through the available settings of the option (second pump, **THERMAZONE™** option)).
 2. Release the control when the LED displays your desired selection.
- THERMAZONE™ Option:** the range is 6-1, 6 being the highest (most heat) setting. The **THERMAZONE™** heater defaults to the highest setting.

Operating the Chromotherapy Light ✨

1. Press the light control ✨ (the LED displays the available light options: light wash, stop, white, blue, aqua marine, green, orange, red, purple, stop).
2. To turn off the chromotherapy light, press and hold the light control for 3 seconds. Note: when the light will be turned on again, the light will start with the last option selected.

Storing and Retrieving Personal Settings 1 2 3

1. Set the pump, blower and/or light controls to your preference.
2. Press and hold one of the personal setting controls until "STO" appears on the LED display. Your personal settings profile is now stored.
3. Retrieve stored personal settings by pressing one of the personal setting controls. The "USR" option appears on the LED display, the timer automatically sets itself to 20 minutes and the controller preferences you set are activated. Any further adjustments you make to your settings are not automatically stored; you must repeat steps 1 and 2 to store any new settings.

Turning off the Controls

1. To turn all controls off simultaneously, press the timer control once. The "OFF" option appears on the LED display.
2. To turn off an individual control, press once on the associated control. The "OFF" option appears on the LED display.

ELECTRONIC CONTROL

TRUE WHIRLPOOL® AND AEROEFFECT® SYSTEMS

 The system starts or stops. The system always starts at maximum speed.

 The whirlpool system starts or stops. The whirlpool system always starts at maximum speed.

 The air system starts or stops. The air system always starts at maximum speed.

 Press down to increase or reduce speed.

 1st setting: speed varies gradually from maximum to minimum and returns to maximum.

2nd setting: the systems stops and starts up again in an alternating manner.

3rd setting: returns to maximum speed.

Note: The system stops automatically after 20 minutes.

Advanced function: A one-minute drying cycle starts up 20 minutes after complete stoppage of the blower (Air system).

ELECTRONIC CONTROL CHROMATHERAPY LIGHT

 The light will go through the settings (the light wash option starts, the light stops, white, blue, aqua marine, green, orange, red, purple, the light stops)

To turn off the chromotherapy light, press and hold the light control for 3 seconds. **Note:** when the light will be turned on again, the light will start with the last option selected.

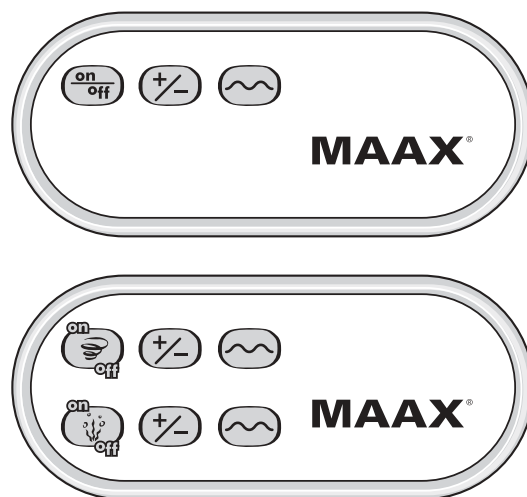

Fig. 12



Fig. 13

HOW TO USE YOUR WHIRLPOOL BATH

Before taking your first bath, read and apply the "Important Safety Instructions" on Page 2.

WARNING To reduce the risk of injury, do not permit children to use the whirlpool unless they are closely supervised at all times. Those requiring supervision for any reason, should never be allowed to use the whirlpool unattended. Persons under a doctor's care, pregnant women, persons with high blood pressure, heart disease, diabetes, or any serious illness, should not use a whirlpool without prior consultation with their physician. Never use a whirlpool while under the influence of any drugs or alcohol.

Do not use the whirlpool if protective cover is not installed on the suction intake. Keep foreign objects, including hair, away from the suction intake as they could block the intake or get caught in it. For comfort and safety, persons with long hair should tie their hair in a bun to keep it out of the water and away from the suction fitting. Never place your head below the surface of the water.

TIME TO RELAX

It's time to relax, unwind, daydream, meditate, etc. Taking a whirlpool should put no pressure on you. Lay back and relax while the effervescent whirlpool action works on your body and floats your cares away.

WATER TEMPERATURE

Warm to moderately hot water is ideal for a relaxing and comfortable whirlpool bath. That temperature is someplace between 100° F and 102° F. The maximum water temperature should never exceed 104° F. If you're interested in knowing the exact temperature of the water, a thermometer can be purchased at a pool and spa shop, or if your system uses the electronic control with back lighting the LCD displays the temperature when the system is on. Try cooler water for an invigorating whirlpool.

Temperatures exceeding 104°F may induce hyperthermia. Hyperthermia occurs when the internal temperature of the body reaches a level several degrees above normal body temperature of 98.6° F. The effects of hyperthermia include; failure to perceive heat, failure to recognize the need to exit the whirlpool and unawareness of pending hazards.

FILLING THE TUB

When the tub is filled with water above the highest jet, step in and sit down before turning the whirlpool on. Do not fill over the air controls or bath waste handles. We recommend this procedure for two reasons. Some switching systems will not work unless the bather is in the whirlpool and the action of the water can alter your sense of touch and balance as your foot "seeks" the bottom of the tub.

TURNING ON THE WHIRLPOOL

Turn on the pump by pressing or touching your control as described previously on pages 7 and 8.

TUNING YOUR WHIRLPOOL FOR PERSONAL PLEASURE

The whirlpool may be set to your personal preferences. The air controls in the open position, turned fully clockwise, will provide a more vigorous water action. Turning them counter clockwise softens the effect (see Air Volume Control on page 4, fig. 2). The Whirlpool Jets (page 4, fig. 1) are adjustable and changing their positions can effect the whirlpool action. Generally, when the nozzle is centered, the strongest whirlpool is created. Turning the nozzles downward and more towards the center of the whirlpool bath, slows down the action.

BATH ADDITIVES

A drop or two of a biodegradable liquid soap, such as Basic H by Shaklee is enjoyable in a whirlpool bath, but a drop too much will cover you with bubbles and overflow onto the floor. Most people enjoy having a few bubbles floating around them. **Pearl does not recommend using use oil based products because the oil will settle in the whirlpool system.** (The oil can also create an environment conducive to bacterial growth.) However, if you choose to use oil based additives, you

must clean the system as outlined on the following page immediately after use. Bath Shops have a variety of products usable in your whirlpool bath, that do not contain oil. They have many fragrances that can enhance your whirlpool pleasure. Epsom Salts can be used in your whirlpool, but there are other mineral salts available that can also help relieve aches and pains. If you do not have a Bath Shop in your neighborhood, ask your pharmacist or a consultant at a Cosmetics Center for these products. **Be sure that any items you select for your bathing pleasure do not contain OIL ADDITIVES!**

Enjoy your whirlpool... There is no finer whirlpool made than a MAAX Pearl Whirlpool... It is the only one that is patterned after those used in hospitals and athletic departments.

HINTS FROM MAAX

Apple cider vinegar can help relieve achy muscles or flaky, itchy skin. It will both relax and invigorate your body when one cup is added to your whirlpool bath. The odor from the vinegar will only remain a few minutes. You will feel squeaky clean. The vinegar is also helpful in keeping the whirlpool system clean.

Try this! Massage the soles of your feet, one at a time, directly in front of a jet, but not so close that the whirlpool stops activating. Reflexologists say that there are nerve endings on the bottom of your feet that affect every part of your body. And it feels great!!

The best time to trap that moisture in your skin is immediately after using the whirlpool. An inexpensive and very effective moisturizer is petroleum jelly. After bathing, while the body is still wet, rub in a little amount of the jelly. Continue wetting body until the jelly is spread evenly and does not appear greasy. Many exclusive health spas use this method. You will be surprised at how soft and smooth your skin feels. Remember, it will not stay greasy if you keep adding water.

How about a facial? This is a good time for it unless you are sharing your whirlpool. Eggs are readily available and have been acknowledged as skin beautifiers for centuries - for all types of skin. Beat an egg until frothy, apply to face and neck. It will draw out impurities and refine the pores as it dries. Egg yolk, lightly beaten with a fork, then smoothed on skin and allowed to dry, is a comfortably gentle skin firmer for dry or normal skin.

USER MAINTENANCE INSTRUCTIONS

CLEANING THE TUB SURFACE

For daily maintenance cleaning, use a moist cloth and gentle liquid detergent.

For acrylic surfaces, occasional use of a special acrylic surface cleaner will add luster and protect the finish.

Proper care and maintenance will preserve the high gloss acrylic finish. To properly clean the surface, wipe with a soft damp cloth, or sponge, using household soap or liquid detergent. **DO NOT USE abrasive cleaners, scrapers, metal brushes, or any items or products that could scratch or dull the surface.** HARSH CHEMICALS SHOULD NOT BE USED ON SURFACE.

The jets can be removed for cleaning. Use wrench provided with the tub. Do not remove the protective cover on the suction return for cleaning. The only time the protective cover is removed is to replace the decorative ring.

Alcohol may be used to remove glue, adhesives, etc. from the surface.

CLEANING THE PUMP AND PLUMBING SYSTEM

After the tub is installed and ready to use, remove all construction debris and clean the tub and pump system. Clean the the pump and plumbing system before the first use and every month thereafter, regardless of utilization. This is easily done as follows:

1. Set air control knobs to the closed position (turn counter clockwise).
2. Using hot water only, fill the tub to at least 2 inches above the highest jet.
3. Add 2 tablespoons of low sudsing automatic dishwasher detergent. Every other month use 1/2 cup of household bleach for cleaning the system, along with the detergent powder.
4. Operate whirlpool for 20 minutes.
5. When the pump system stops (except on Air Switch units which have to be turned off manually), drain the water from the tub.

CAUTION

Caustic drain openers will damage the surface and the pump. Should you experience a clogged drain, call a plumber to remove the trap for cleaning. Extreme heat from portable heaters and cigarettes can damage the surface of the tub. **We do not recommend the use of oil based bath additives.** Epsom salts or other mineral salts may be used in the tub.

MINOR SCRATCHES AND SCUFFS

The procedure to remove light surface scratch or burnish marks is quite simple. Apply automobile rubbing compound and lightly buff, then apply paste wax and lightly buff again. This will return the original shine.

MAJOR REPAIRS TO THE SURFACE

Should a deep scratch or more serious damage occur, please call your installation professional.

JET HARDWARE WRENCH

The wrench that is included with your tub is used to remove hardware for cleaning, replacing or adjusting the nozzle. Refer to the diagrams below for how to use this wrench. Again, use no abrasive cleaners. Use mild detergent and a soft cloth or sponge when cleaning. Do not remove the cover on the suction return. This cover is removed only when replacing the decorative ring (fig. 14).

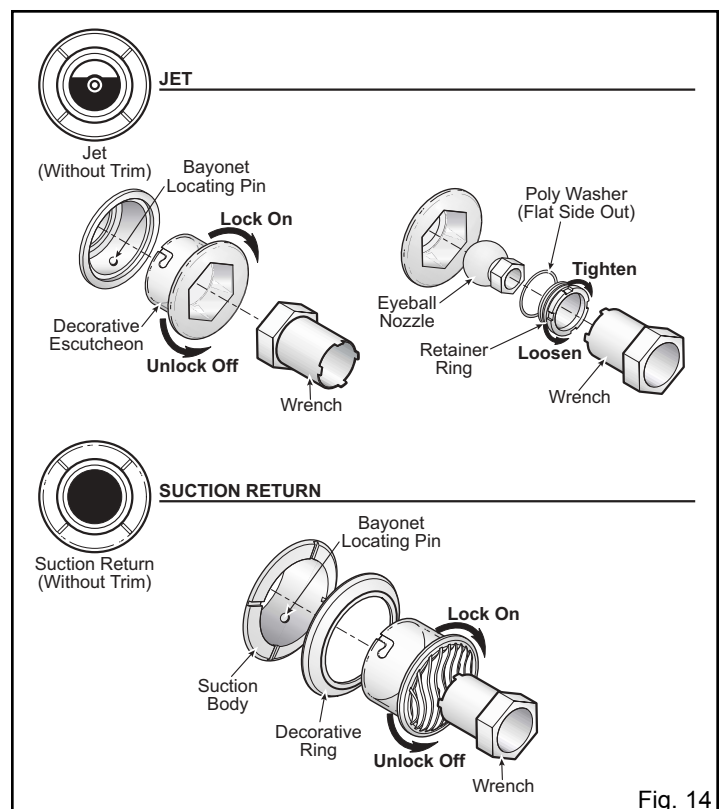

Fig. 14

TROUBLESHOOTING

WHIRLPOOL SYSTEM

Pump is not functioning smoothly.

- Adjust jet nozzle direction.
- Unscrew the filter from the suction fitting and clean. Never obstruct the suction filter.
- Make sure that pipe connections to the motor are tightened enough (tighten by hand).
- It is highly inadvisable to wash your hair while the whirlpool pump is operating. Loose hair could eventually plug or damage the pump.

A jet is not functioning.

- Open both air controls and try again. If jet still does not work, verify that jet hole is clear of all debris. If problem persists, contact Technical Service.

A jet is leaking.

- Put a silicone seal around the jet body on the outside of the bathtub. If jet still leaks, contact Technical Service.

Suction fitting is leaking.

- Put a silicone seal around suction body on the outside of the bathtub. If suction still leaks, contact Technical Service.

Pump will not turn on.

- Some bathtubs are fitted with a low water detector that prevents the motor from starting if the water level is insufficient. Fill tub with water and try again.
- Make sure that the electric connection between the pump, electronic box and the electronic control panel is well established and that all fuses are functional. Reconnect if necessary.
- Verify that electricity is supplied to pump via a ground fault circuit interrupter (GFCI Breaker).

AIR SYSTEMS

Blower does not turn on.

- Make sure that the electric connection between the pump, electronic box and the electronic control panel is well established and that all fuses are functional. Reconnect if necessary.
- Verify that electricity is supplied to blower via a ground fault circuit interrupter (GFCI Breaker).

Blower operates, but no air is coming through certain jets.

- If none of the jets are working, check to see if the hose between the blower and the air distributor is properly connected and not damaged.
- Verify that jets are clear of obstructions. If so, put one inch of hot water in the bathtub and clear jets by operating blower on highest setting.

Blower operates for a period of time, then switches off.

- The system is programmed to stop automatically after 20 minutes. To restart, push the ON/OFF switch.
- The motor incorporated in the blower over heats. Allow motor to cool down for approximately 40 minutes.

Air entering the bathtub through jets feels cold.

- Due to the difference of temperature between the water and the air, the air may feel cool to certain people. To verify the operation of the air heater, fill the bathtub to working level and operate blower on the highest setting for approximately 5 minutes. Carefully feel the flexible connection hose where it connects to blower. The hose and its immediate area should feel warm to the touch. If not, contact Technical Service.

Blower does not execute the drying cycle.

- Reset control by turning the breaker off and back on.

Electronic controls

The electronic control fails to operate.

- Verify electric power supply. Reset circuit or replace fuse if necessary.
- Verify all electrical connections (including keypad connection).
- If the system has been functioning for quite some time, it is possible that the thermal protection has shut off the motor. Switch the system off and wait for at least 30 minutes before starting it up again.
- If you have added an extension cord, make sure that it has been certified by the electronic control manufacturer. It could be the cause of your problem.

Back lighting control only

A “C##” code appears on the LED display.

- No action is required. The “C##” is pre-set by the manufacturer to indicate to the controller the features included with your jetted bath.

A “E##” code appears on the LED display.

- The product requires servicing. Do not attempt to service the controller yourself. Contact Technical Service.

“No H2O” appears on LED display.

- The controller does not detect ant bath water. Verify that the level of bath water is high enough, and adjust as required.

The controller lights have dimmed.

- No action is required. The controller lights dim after 30 seconds of no activity. The controller lights brighten again if any controls are adjusted.

The “Dry” option appears on the LED Display and the air jets have started operating, but the bath is empty and has not been in use for 15 minutes.

- No action is required. The air jets are blowing residual bath water out of the air tubes. Once this process is complete (after 30 seconds), “Dry” disappears from the LED display.

CABLE OPERATED DRAIN & OVERFLOW

The bath water drains very slowly.

- Bath waste plug is set too low; remove bath waste plug and adjust the height by backing out and tightening the lock nut as in the set screw.

The bath waste will not stay open while draining.

- Contact Technical Service for help.

IN-LINE HEATER

The in-line heater does not heat sufficiently.

- Check the power to the GFCI circuit breaker for the heater.

NOTE: IF ABOVE TROUBLE SHOOTING GUIDE IS INEFFECTIVE, CALL OUR TECHNICAL SERVICE AT (800) 328-2531 OR (763) 424-3335. PLEASE HAVE THE FOLLOWING INFORMATION READY FOR THE SERVICE TECHNICIAN:

- Name, address, and telephone number of the person we can contact to set up an appointment.
- The model and serial number of your whirlpool. You will find this information on the cover of the Owners Manual or on a white sticker where the pump is.
- Have a complete description of the problem to aid the technician in his determination how best to solve the problem.

REMEMBER: An in-line heater is designed to maintain water temperature, not to substitute for a water heater. It is common for the heater indicator light to fluctuate on and off in normal operation.

LIMITED WARRANTY

Pearl Baths, Inc. (hereafter "MAAX") offers the following express limited warranty on each of its products. This warranty extends only to the original owner/end-user for personal household use. For commercial uses, additional limitations apply.

MAAX warrants **acrylic units** to be free from defects in workmanship and materials under normal use and service for a period of twenty five (25) years from the initial date of purchase by the owner/end-user, contractor or builder from an authorized dealer.

MAAX warrants **whirlpool motors/pumps** to be free from defects in workmanship and materials under normal use and service for a period of five (5) years from the initial date of purchase by the owner/end-user, contractor or builder from an authorized dealer.

MAAX warrants **blowers** to be free from defects in workmanship and materials under normal use and service for a period of five (5) years from the initial date of purchase by the owner/end-user, contractor or builder from an authorized dealer.

MAAX warrants **whirlpool and air systems** (except perimeter air system check valves that have a 25 years warranty - see below) to be free from defects in workmanship and materials under normal use and service for a period of two (2) years from the initial date of purchase by the owner/end-user, contractor or builder from an authorized dealer.

MAAX warrants **Perimeter air system check valves** to be free from defects in workmanship and materials under normal use and service for a period of twenty five (25) years from the initial date of purchase by the owner/end-user, contractor or builder from an authorized dealer.

MAAX warrants **glass mirrors and electrical components** to be free from defects in workmanship and materials under normal use and service for a period of two (2) years from the initial date of purchase by the owner/end-user, contractor or builder from an authorized dealer.

MAAX warrants **ceramic cartridges for faucets** against any leaks resulting from normal use by the owner/end-user, contractor or builder for a limited lifetime.

MAAX warrants **faucet finishes** to be free from defects in workmanship and materials under normal use and service by the owner/end-user, contractor or builder. MAAX offers a lifetime warranty on its **Chrome, Polished Brass and Brushed Nickel finishes**.

Any product reported to the authorized dealer or to MAAX as being defective within the warranty period will be repaired or replaced (with a product of equal value) at the option of MAAX. This warranty extends to the original owner/end-user and is not transferable to a subsequent owner.

Neither the distributor, authorized MAAX dealer nor or any other person has been authorized to make any affirmation, representation or warranty other than those contained in this warranty; any affirmation, representation or warranty other than those contained in this warranty shall not be enforceable against MAAX or any other person.

MAAX reserves the right to modify this warranty at any time, it being understood that such modification will not alter the warranty conditions applicable at the time of the sale of the products in question.

Limitations

This warranty shall not apply following incorrect operating procedures, breakage or damages caused by fault, carelessness, abuse, misuse, misapplication, improper maintenance, alteration or modification of the unit, as well as chemical or natural corrosion, accident, fire, flood, act of God or any other casualty. This warranty shall not apply to stain or malfunction caused by ferrous water, hard water or salty water.

The owner/end-user of the product covered this warranty is entirely responsible for its proper installation and electrical wiring. MAAX neither installs nor supervises the installation, nor hires a contractor for this purpose, and consequently cannot be held responsible for any defect, breakage or damage caused thereby or resulting thereof, either directly or indirectly. The owner/end-user must provide access to the components of the product as described in the installation guide, so that MAAX can execute the warranty specified herein. If such access is not available, all expenses to provide said access will be the responsibility of the owner/end-user.

This warranty does not apply to products or equipment not installed or operated in accordance with instructions supplied by MAAX and all applicable rules, regulations and legislation pertaining to such installations.

MAAX strongly recommends that its products-for example, but without limitation, shower doors and other items-be installed by professionals with experience in bathroom products. Installation of shower doors by an inexperienced person may result in glass breakage and, consequently, cause personal injury or death.

MAAX is not liable for any costs, damages or claims resulting from the purchase of products that do not fit through openings or existing structures. MAAX is not liable for any costs, damages or claims resulting from defects that could have been discovered, repaired or avoided by inspection and testing prior to installation.

MAAX is not liable for personal injuries or death to any person or for any direct, special, incidental or consequential damage, loss of time, loss of profits, inconvenience, incidental expenses, labour or material charges, or any other costs resulting from the use of the product or equipment or pertaining to the application of the present warranty, or resulting from the removal or replacement of any product or element or part covered by this warranty.

EXCEPT AS OTHERWISE PROVIDED ABOVE, MAAX MAKES NO WARRANTIES, EXPRESS OR IMPLIED, INCLUDING WARRANTIES OF MERCHANTABILITY AND FITNESS FOR A PARTICULAR PURPOSE OR COMPLIANCE WITH ANY CODE.

In any case, MAAX cannot be liable for any amount over and above the purchase price paid for the product by the owner/end-user, contractor or builder.

Commercial Limitations

In addition to the above conditions and limitations, the warranty period for products installed for commercial applications or used in commercial ventures is of one (1) year from the initial date of purchase by the owner/end-user, contractor or builder from an authorized dealer. MAAX is not responsible for loss of use or profit under any circumstances. If the product is used as a display, the warranty period begins when the product is placed on display.

This warranty gives the owner/end-user specific legal rights. The owner/end-user may also have other rights which vary from one state and/or province to another.

Warranty service

In order to obtain service provided under this warranty during regular business hours, contact the dealer or distributor who sold the unit, or MAAX directly. MAAX will provide the warranty service described above when the following conditions have been met: (1) the failure is of the nature or type covered by the warranty; (2) the user has informed an authorized MAAX Agent or Warranty Service Department representative of the nature of the problem during the warranty period; (3) conclusive evidence (e.g., proof of purchase or installation) is provided to the foregoing by the user proving that the failure occurred or was discovered within the warranty period; and (4) an authorized independent service person or company representative has been permitted to inspect the product during regular business hours within a reasonable time after the problem was reported by the user.

MAAX's warranty obligation shall be discharged upon tender of replacement or repair. The purchaser refusal to accept the tender terminates MAAX's warranty obligation.

MAAX products are certified by one or more of the following certification agencies: CSA, UL, IAPMO, ULI, INTERTEK (ETL), WARNOCK HERSEY, US TESTING, NAHB

Certain models are pending approval. Certification may be ended by MAAX or certification agencies without notice.

PEARL, PEARL LOGO, TRUE WHIRLPOOL are registered trademarks of Pearl Baths Inc.

THERMAZONE, DUCETTA, PALLADIUM, TRILLIUM, DESIGNER, CLASSIC are trademarks of Pearl Baths Inc.

MAAX, AEROFEEL, AEROEFFECT are registered trademarks of MAAX Canada Inc.

The *THERMAZONE*® system is patent pending in the United States

Save this manual for future reference

NOTICE INSTALLER:

Underwriters Laboratories and some state agencies require that this Owner's Manual be left with the home owner or with the tub after installation.

Important safety instructions, warranty information and the product registration card are contained within.

***TAPE THIS PACKET TO THE TUB OR
LEAVE IN AN OBVIOUS PLACE***

MAAX[®]



P E A R L

Pearl Baths Inc.
9224 73rd Avenue North
Minneapolis, MN 55428
Phone: (763) 424-3335
Toll Free: **(800) 328-2531**
Fax: (763) 424-9808

www.maax.com